

LC40-12M High-efficiency PV Module

Features

- high energy yields ensured by high conversion efficiency
- sturdy, clear-anodized aluminum frame with pre-drilled holes for quick installation
- advanced EVA encapsulation with triple-layer backsheet, meets the most stringent safety requirements for high-voltage operation
- reliable bypass diodes to prevent overheating (hot spot effect) and to minimise power loss by shading
- manufactured in ISO 9001:2000-certified factory

Applications

- water pumping
- water purification systems
- remote village lighting
- solar home systems
- street and camp lights
- traffic signals
- medical facilities in remote areas
- microwave/radio repeater stations
- battery charging
- on-grid applications

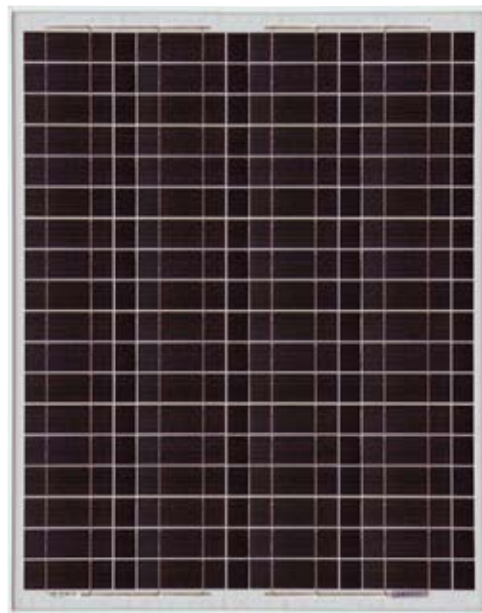

photo may differ

Warranty

- Warranty: 2 years
- Performance guarantee:
up to 10 years (90% power output)
up to 20 years (80% power output)

Details according to warranty issued by LORENTZ

Standards

LC40-12M meets the requirements for IEC and CE.



Specifications

Electrical Data

Peak power	P _{max}	[Wp]	40
Tolerance		[%]	+ 15/-5
Max. power current	I _{mp}	[A]	2.3
Max. power voltage	V _{mp}	[V]	17.1
Short circuit current	I _{sc}	[A]	2.6
Open circuit voltage	V _{oc}	[V]	21.7
Temperature co-efficient for P _{max}		[%/°C]	-0.50
Temperature co-efficient for V _{oc}		[%/°C]	-0.35
Temperature co-efficient for I _{sc}		[%/°C]	0.09
Max. system voltage		[V]	600

All technical data at standard test condition:
AM = 1.5, E = 1,000W/m², cell temperature: 25 °C

Cells

Number of cells in series	36
Number of cells in parallel	2
Cell technology	monocrystalline
Cell shape	rectangular

Electrical Performance

Electrical Performance

for different temperatures, at AM=1.5, E=1,000W/m²

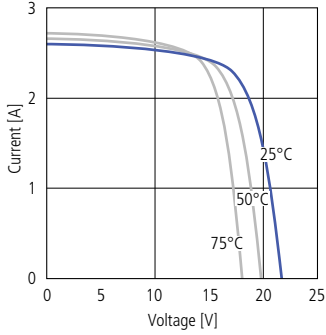

Electrical Performance

for different irradiation, at 25 °C

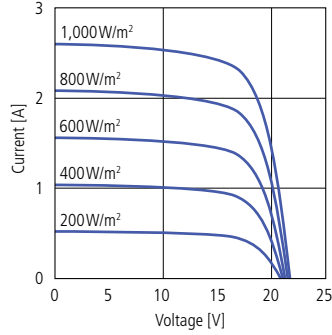

Temperature Dependence

of I_{sc}, V_{oc} and P_{max}

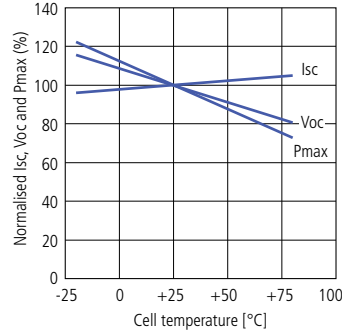

Irradiation Dependence

of I_{sc}, V_{oc} and P_{max} at 25 °C

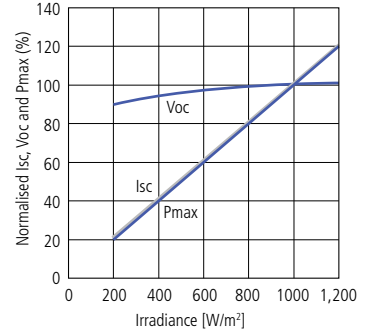

Physical Specifications mm [in]

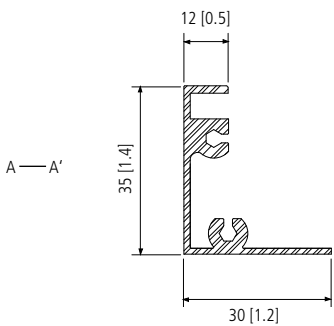
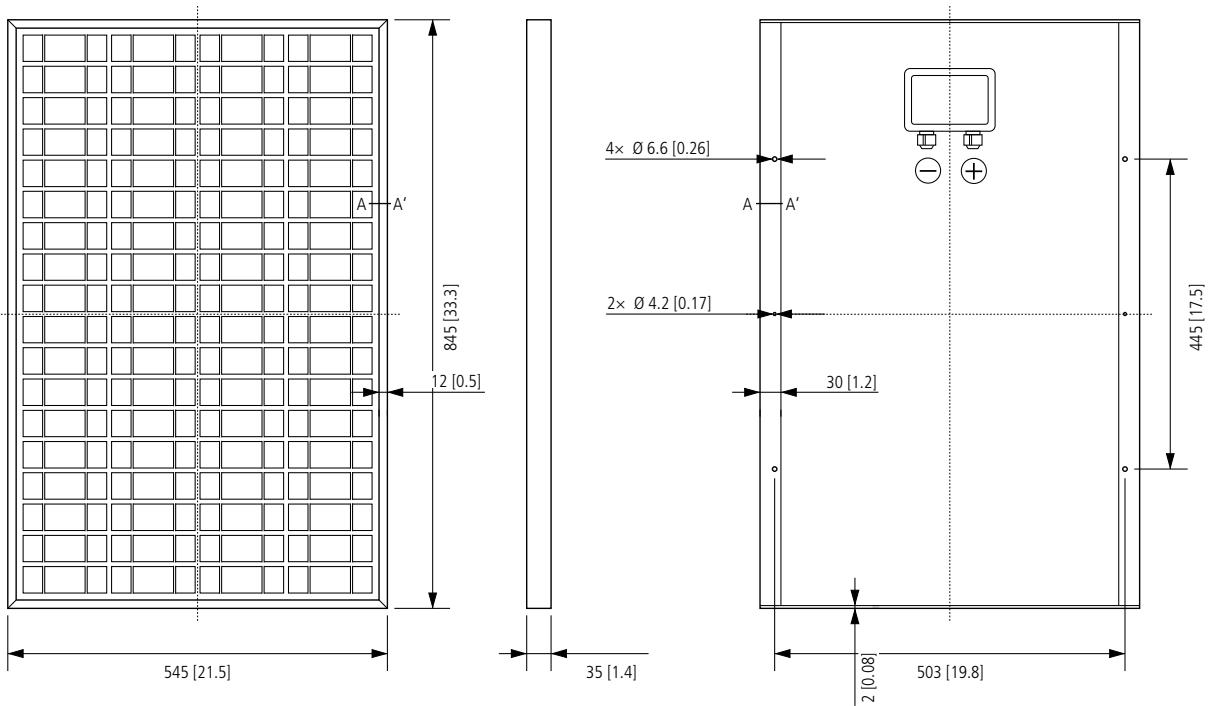

Weight	[kg]	7.0
Dimension	[mm]	545 × 845 × 35