

SOLON Top Class

Stand alone sinewave inverter

SOLON Top Class 13/12

SOLON Top Class 20/12

SOLON Top Class 15/24

SOLON Top Class 22/24

SOLON Top Class 30/24

SOLON Top Class 22/48

SOLON Top Class 35/48

SOLON Top Class 25/110

SOLON Top Class 20/36

Instructions for installation and operation



SOLON Inverters AG
CH-8730 Uznach/SG
Switzerland

www.solon.com

SOLON  *Don't leave the planet
to the stupid*

About this Manual

Congratulations on your purchase of a SOLON sinewave inverter. You are the owner of the finest engineered and highest quality sinewave inverter. We have dedicated our products, our services and ourselves to the satisfaction of every customer.



This manual for installation and operation contains important information about this unit. Please familiarise yourself with all the information contained in these instructions before installing and operating this unit. This will help you to get acquainted properly with this unit and make full use of its advanced technical features under all operating conditions.

Should you encounter problems while installing or running this unit, please contact the dealer you purchased the unit from or a dealer authorised by SOLON INVERTERS. Improper assembly, installation and maintenance may impair the safety and function of this unit. For this reason make sure that you understand all the information in this manual before beginning the assembly and installation procedure.

SOLON Inverters AG, CH-8730 Uznach/SG

Safety symbols

The following safety symbols have been placed through-out this technical description to indicate dangerous conditions and important safety instructions.



Warning of dangerous electrical tension

Disregarding of warnings may cause heavy bodily injury or death.



Warning / Danger

This indicates a fact or feature very important for the safety of the user and / or which can cause a serious hardware defect if not applied appropriately.



Hot Surface

To reduce the risk of burns do not touch surface.

Safety Instructions

- In principle the general regulations for security and personal safety are valid for all operation on the sine wave inverter unit.
- The inverter was built and examined in accordance with the actual safety regulations for electrical devices. In order to guarantee a safe handling of the equipment, the safety instructions in this manual must be carefully followed.
- For any works on the inverter and electrical connections inclusive grounding, protective ground and lightning protection, the national and regional regulations are valid and must be carefully followed.
- **Any works on the inverter and electrical connections may be implemented only by electrical specialists.**

An electrical specialist has the suitable technical training, knowledge and experience to recognize and avoid dangers by electricity.



Warning! In this unit potential differences of up to 1000V occur during operation and can result in death or serious bodily injury. Use extreme caution while operating and always observe precautions as:

The unit must be connected by a professional electrician only. Only specially trained maintenance and service personnel are permitted to test and repair this unit. This personnel further must be familiar with this manual and all domestic regulations.



Safe handling of this inverter is only ensured by correct installation and mounting according to regional valid regulations. Consider the lightning protection regulations!

Any work performed on this unit, its installation and electrical connection must be carried out in compliance with national electric codes and local regulations, which may deviate from those contained herein. Refer to responsible authorities for relevant information.



No AC-generator or power supply is allowed to connect to this unit. Connecting mains power, AC-Generator or an other inverter to AC-output will damage the unit immediately. Excess voltage applied to the inputs and outputs may result in destruction of the unit. Charging the battery with a dynamo while the inverter is connected to the battery, may damage the inverter. Please ask your dealer if you have any questions. Take care of regulations for lightning protection.

The unit is tested by the manufacturer and it is not allowed to change anything! Without a written permission of SOLON Inverters AG you will loose warranty if you repair the unit. Please refer to the warranty information.



Operate the device only when all factory-supplied covers are available and in place. Temperatures at the heat sink of the device may be as high as 80 degrees C during operation. Obstruction of the ventilation of the unit may result in overheating and thus in failure of the unit.

Always keep the unit and the ventilation slots clean. Do not cover up or place any item on ventilation holes or cooling components.

Please note the permissible ambient conditions for operating the unit.

Automatic restart of the unit may occur after fault clearance.

Warning! Please note that also under standby operation, 230V test voltage pulses are present at the inverter AC-output. The inverter is still ready to run. To be sure that the unit is completely switched off you have to switch the main circuit breaker in OFF-position or disconnect the battery. Inbuilt, large electrolytic capacitors will hold DC-voltage for extended periods.



Do not use any measuring equipment damaged or defective.

Contact with energized parts can result in serious or fatal injury. Please note that, even under excessively light load or in stand by operation, high voltage can be present at the AC-output.

Limitation of liability

Since neither the observance of these instructions for installation and operation, nor the conditions and methods of installation, operation, utilisation and maintenance of the unit can be supervised by SOLON Inverters AG, we don't assume any responsibility or liability for loss, damage or costs arising from using this unit or in any way connected with faulty installation, improper operation or incorrect utilisation and maintenance.

Furthermore we don't assume any responsibility for infringement of patent rights or violations of the rights of third parties arising from the utilisation of this unit.

We reserve the right to make product changes, change technical specifications or these instructions without prior notice.

Important! Please be informed that units without CE-declaration can only be used on your own liability in European countries. If you have an unit without CE please contact your local dealer.

WARNING! Unauthorised repairs and operation of this device for any use other than that for which it was intended will result in loss of warranty. If you have problems with the unit SOLON INVERTERS will provide you with the authorization necessary to return or repair a unit.

SOLON Inverters AG
Burgerfeldstrasse 19
CH-8730 Uznach/SG
Switzerland

Phone: +41 55 246 41 14
Fax: +41 55 246 41 16
Internet: www.solon.com
Email: inverters@solon.com

Environmental protection



Recycling raw materials instead of waste disposal. This unit is built of valuable materials and is easy to recycle. The unit, accessories and packaging should be sorted for environment-friendly recycling. Please keep packaging for retransport the inverter later.

To prevent damage during transport we have to use and bill you a new packaging if we receive the unit not with original packaging. Thank you.

Maintenance and Spare parts

This unit is maintenance-free.

Proper functioning of the unit and electrical connections must be inspected at regular intervals – we recommend once a year – by trained electrical specialists. The routine inspection should include the entire electrical system.

Should malfunctions of the unit occur despite these inspections, the unit must be returned to the manufacturer for repair. Original spare parts are only available from SOLON Inverters. SOLON Inverters AG will provide you with the authorization necessary to return a unit for repair. Before you call please prepare you for the following questions: Type of unit, DC-voltage, manufacturing date, date of purchase, kind of fault, connected loads.

1. Unpacking the unit

Please check if the unit has no visible damage. If the unit is damaged you must inform your dealer within 3 days after receiving the unit.

2. Function, technology

This inverter is designed to convert DC-battery voltage (direct voltage) to 230V AC (sinusoidal alternating voltage). Voltage controlled, the inverter provides a stabilised, crystal-accurate alternating voltage (different voltages and frequencies refer to the indication label). With a sinewave inverter almost any type of electric consumer may be connected as for example energy saving lights, fluorescent tubes, computers, Radio and HIFI-equipment and other household appliances, freezers, pumps, motors etc.

Due to a high degree built-in safety, excellent dynamic response, a surge-proof and overload-proof output, it is very simple to operate a broad range of applications.

The "heart" of the inverter is a very powerful RISC-microprocessor of the latest generation. This microprocessor is responsible for the real time computing of the output sinewave shape, for the process control of the output voltage, for the supervision of the battery (dynamic) and the inverter temperature.

The power stage features modern Power Mosfet transistors. These transistors are the key to the high partial-load efficiency and superb overload capability. The power transistors are protected by independent intelligent protection circuits. The inverter is further more protected against DC-overvoltage (static) and short circuit on AC-output.

The battery input side is equipped with a thermal/magnetic circuit breaker for extreme overload protection of your system (SOLON Top Class 13/12, SOLON Top Class 20/12, SOLON Top Class 30/24 has no circuit breaker at the input).

The superb toroidal transformer has very low magnetic losses, high efficiency and a very low RFI-radiation level. The transformer design provides a high efficiency over a wide operating range. No electrical connection between DC-input and AC-output due to the transformer. It complies with the following guidelines EN61558 (IEC61558).

The whole control electronics are manufactured in SMD technology to ensure a high standard of quality and reliability.

Schematic

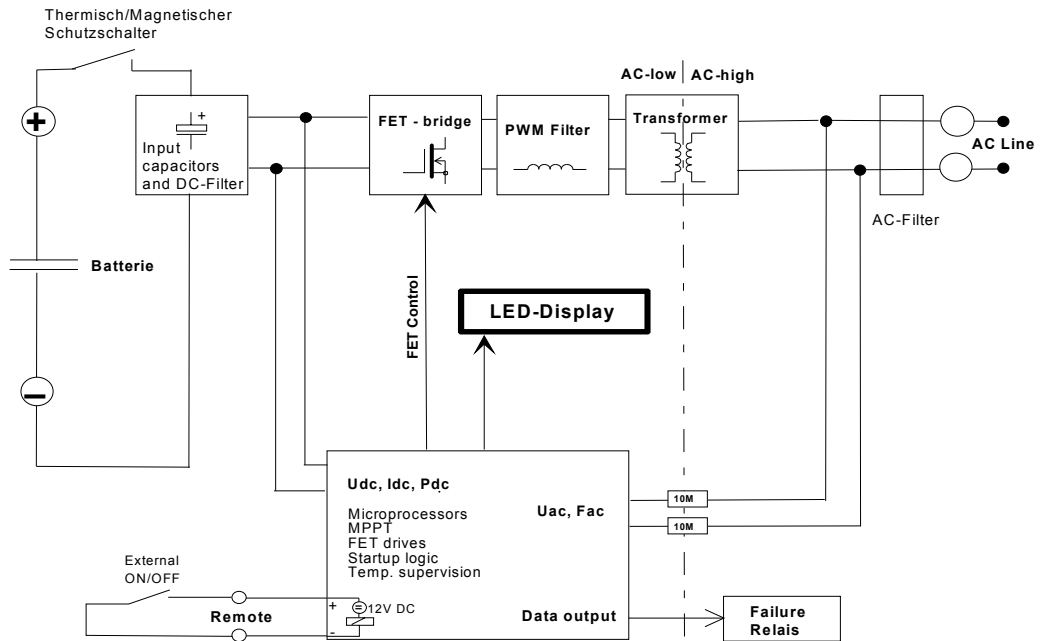

3. General information

Always check the power draw of your appliances. Electrical equipment as motors, pumps, compressors etc. need more power while starting up. Start up power draw can be much higher than P_{nom} . For this applications the inverter is able to supply up to 300% surge power for a short time.

Be careful if you use pumps. Power declaration on pumps is normally not the electrical input power of the pump! The inverter switches off automatically if surge power is too high. If ambient temperature is higher than 20 degrees C, P_{nom} and overload capability of the inverter will be reduced.

Due to reduced cooling capacity' P_{nom} of the inverter is reduced if operation altitude is above 900 m ASL. Reduction of P_{nom} is approx. 1,5% per every additional 100 m more altitude.

Example: If a 1000 VA inverter is installed as high as 2500 m ASL maximal P_{nom} will be at 780VA only! If you use more power, overheating and associated premature disconnection of the inverter must be anticipated.

If you use the inverter under above conditions we recommend to use a bigger inverter.

4. Installation

Safety advices



- Be sure that all demands written in the topic "safety regulations" are kept.
- Do not install inverter outdoor. Install unit only in room and protect the inverter from rain and moisture.
- Adequate ventilation. Keep min.10 cm distance to other objects (except mounting side). Do not block ventilation openings at mounting side. Do not put any items on heat sink.

The selection of a safe location for installing the inverter depends on the following criteria:

- Check indication label for correct DC-Voltage and AC-Voltage.
- The inverter can be used in any position.
- Protection from unauthorized access in particular of children's.

- Dry, dust free surroundings (max. 95% humidity, not condensing).
- Short distance between battery and inverter. Use a grounded metal pipe to reduce RFI emission and to prevent surroundings of fire. The inverter should not be mounted in the same room as the batteries are (gas of the batteries during charging).
- Adequate ventilation. Keep min.10 cm distance to other objects (except mounting side)
- Battery capacity must be at least 400Ah – 1000Ah. Using a smaller battery may damage the unit.
- If other DC-units are installed at the same battery, contact your dealer for more information.
- Protection of inverter and battery from the effects of water.
- Temperature range 0–50 degrees C.
- Only specially trained maintenance and service personnel are permitted to test this unit. This personnel further must be familiar with this manual and all domestic regulations before installing this unit.

5. Connecting the inverter

Security advices



- Be sure that all demands written in the topic "safety regulations" are kept.
 - Check if battery voltage and operating voltage correspond with values written on the label of the inverter unit itself.
- Any electrical connections must be carried out by a professional electrician.
 - To be sure that the unit is completely switched off you have to switch the main circuit breaker in OFF-position or disconnect the battery. Inbuilt, large electrolytic capacitors will hold DC-voltage for extended periods.
1. Switch off thermal magnetic DC-Breaker (OFF).
 2. Install AC-output and AC-protective switch (circuit breaker) between output and load (max. current for protective switch according type label on inverter unit). We highly recommend installing additionally an earth leaking circuit breaker for personal safety. Consider the regulations very carefully!
 3. Install DC-Input, cable min. 50 mm². On cable cross section bigger than 35 mm² add pin cable shoe on clamp side. Check polarity carefully, wrong polarity may damage inverter unit. Recommendation: To disconnect the unit from the power source just install a DC-switch (min. 130A switching current) into DC-line direct to the battery.
 4. Secure all connection cables with strain relief.

NOTE: Please exercise extreme care when connecting the unit to a battery. Otherwise the inverter or the battery could be damaged!

Take care of correct grounding of the inverter and your equipment which is connected to the inverter. We recommend to use an earth cable with minimum cross section of 25mm² to ground the inverter.

6. Information for operation

Security advices



- Be sure that all demands written in the topic "safety regulations" are kept.
- If DC voltage is out of range longer then 5 sec., the inverter switches off automatically, LED indication "LOW BATTERY" flashes red. Caution: As soon as DC voltage is back in tolerance the inverter switches automatically on again.



- If AC voltage is out of range, LED indication "AC-OUTPUT" turns to red. The inverter switches off automatically and indication "AC-OUTPUT" flashes red. Caution: After approx. 20 sec. the inverter tries to switch on automatically again.
- Each time a fault occurs, the inverter restarts automatically after 20 seconds or if the parameters (for example temperature) are back in normal conditions after a fault. Time before the unit starts again can be from a few seconds to a few hours! Always switch off the unit if you work at your system or electric consumer.
- For any manipulations and works on the electrical facility or AC-load, always cut off the inverter from the battery (turn DC-switch resp. circuit breaker to OFF position).



Inverter heat sink may be very hot, do not touch surface to reduce the risk of burns.



Protect your inverter from rain. The unit is not designed to be used outdoor.

The DC-input breaker should be in "ON"-position all the time. In case of an error it will switch of automatically. If the inverter is switched off by the small switch at the display unit, the inverter needs no power from the battery. The inverter is short circuit protected at the AC-Output.

DC input of the inverter is monitored for overvoltage and undervoltage. The upper limit is static. If DC-Voltage is too high the inverter will switch off. Automatic restart follows after DC-Voltage is in the normal range.

The lower limit is dynamic (cut off voltage is lower if a big load is in use). This allows an optimal use of the battery capacity and protects your battery during small load operation.

Important: If the inverter has switched off automatically it still needs very little power from the battery!

Important: Always before you switch on the circuit breaker you must switch off the load.

SOLON Top Class, 35/48 and 25/110 only: Both of this inverters are equipped with an alarm relays. This relays is switching before the inverter cuts off due to battery low voltage. With the potentiometer located at the main board you are able to adjust the level for battery low voltage switch off.

7. Status LED-display

LED LOBAT:	Battery voltage low. The inverter switches off automatically if DC-Voltage is out of range for more than 5 seconds (LED is blinking). Warning! The inverter restarts automatically if DC-Voltage is in permitted range.
LED OVERTEMP:	Overtemperature. Overheating as a result of insufficient cooling or extended overload. The inverter switches off automatically after 5 seconds. Warning! The inverter restarts automatically if temperature is in permitted range.
LED AC-OUTPUT:	During normal operation this LED emits a green light. Inverter ON-Output = 230V AC/50Hz. During standby this LED blinks green. Hint: This LED blinks orange before the inverter switches to standby if the load is too small. Use this information to adjust the standby level to your load. If AC-Output transcends tolerance (for ex. because of short circuit at the AC-Output) this LED emits a red light. Warning! The inverter restarts automatically after 20 seconds.
STDBY-ADJUST:	With this potentiometer placed next to the LED's you can adjust standby level in a range from app. 4 – 40 W or you can switch the inverter to continual operation. Turn the potentiometer completely counter clockwise: The inverter is always ON – no sleep mode. Turning the potentiometer clockwise: The standby level (for sleep mode) will increase from app. 4 W to 40 W (see hint).

Important: Each time a fault occurs, the inverter restarts automatically after 20 seconds or if the parameters (for example temperature) are back in normal conditions after a fault. Time before the unit starts again can be from a few seconds to a few hours! Always switch off the unit if you work at your system or electric consumer.

Additional information about standby/sleep mode

This specially designed standby circuit (energy saving circuit) recognizes automatically if power is needed at the AC-Output.

If no power is needed and after a delay of 10 seconds the unit switches into standby/sleep mode. In this operation mode power draw of the unit is less than 2W. Every 800ms the inverter checks the AC-Output by emulating a true sinewave voltage. If power draw exceeds the adjusted sensitivity level the inverter switches on immediately. If no more power is needed the inverter switches back to standby mode after a delay of 10 seconds.

If you use a small not compensated load it may occur that the inverter is switching on and off all the time. If this occurs you should compensate the load or switch an additional load to the AC-output. Note: A lot of electrical equipment needs power even if they are switched off. Especially units as portable radios TV- and video equipment, plug in power supplies etc. may have still such a high power draw that the inverter recognizes a load and is not able to switch into standby/sleep mode.

The sense level is adjustable on the potentiometer next to the LED's. You can adjust sensitivity level from app. 4W to 40 W. Sensitivity level may slightly change depending on DC-Voltage of the battery and temperature of the inverter (app. $\pm 2W$).

Units with remote input

- If your inverter is equipped with remote ON/OFF control use the clamps 1 and 2 to connect an external switch to the unit. This ports are electrically separated from the unit.

The max. length of the wire should not exceed 20 m. The minimum size of the wire is 0.25 mm². Do not connect to power supply!

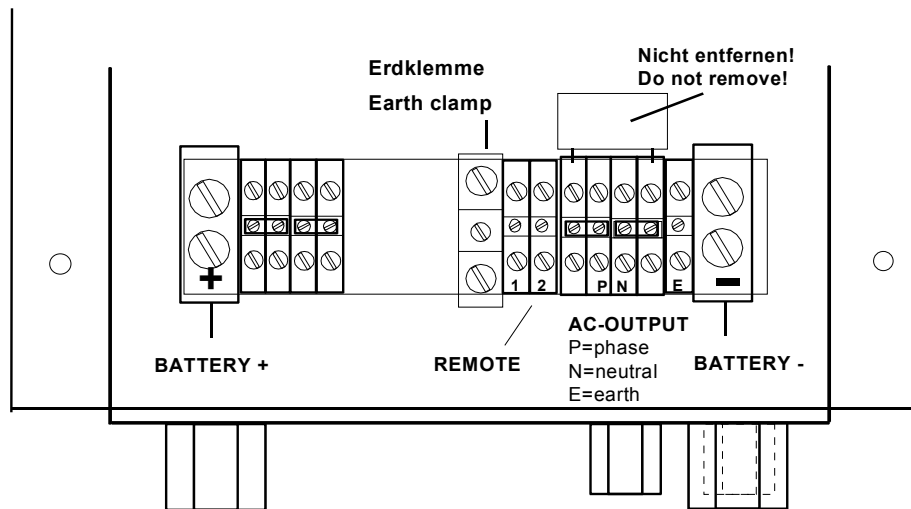

8. Fault clearance



Security advices





- Be sure that all demands written in the topic "safety regulations" are kept
- Before any manipulations and works on the electrical facility or load, always cut off the inverter from the battery (turn DC-switch resp. circuit breaker to OFF position)
- Please note when opening inverter housing:
 - Inside the inverter dangerous electrical tensions are accessible.
 - Do not disconnect ground wire connection to the housing cover.
- Repair works and service on the inverter unit may be only carried out by the manufacturer or an official SOLON Inverters service partner.

AC-Output LED is flashing red and green	refer to point 7. LED-Display
The unit is noisy and switches off	The load is too big, battery is too small
It is not possible to set DC-Circuit breaker ON	wrong polarity at DC-input, wrong installation
DC-Circuit breaker switches to Off-Position	Overload operation for long time, reduce load
No function	Check wiring, check DC-Voltage

9. Technical data

SOLON Top Class	13/12	20/12
		
Inverter		
Rated Voltage UDC _{IN}	12V	12V
Input Voltage Range	10.5 ... 16.0V DC	10.5 ... 16.0V DC
Dynamic Low Voltage Cut Off (depending on load)	10.5 ... 9.0V DC	10.5 ... 9.0V DC
Rated current IDC _{IN}	125A	195A
Current IDC _{IN} max.	340A	520A
Rated Power P ₁₀ (10 min at T _A =20°C) ¹⁾	1400VA	2300VA
Rated Power P ₃₀ (30 min at T _A =20°C) ¹⁾	1300VA	2000VA
Continuous Power P _D	1000VA	1800VA
Rated Output Voltage UAC _{OUT}	230V AC, ± 2% (short circuit proof)	
Output Frequency	50Hz, ± 0.5% (true sinewave)	
Rated Output Current IAC _{OUT}	5.7A	8.7A
Short Circuit Current IAC _K (max. 0.5s)	16A	24A
Allowable CosPhi	0.3 ... 1	
Efficiency Factor max.	92%	93%
Adjustable Standby Level (logarithmic)	5 ... 60W	
Consumption Standby/OFF	ca. 0.5W (Test impulse every 800ms) / 0W	
Consumption 230V AC OK	10W	16W
Reset after Short Circuit	every 60s	
Reset after Overload	every 60s	
Reset after Overtemperature	automatically after reaching semiconductor temp. +45°C	
Reset after Battery failure	automatically after reaching UDC _{IN}	
General data		
Ambient Temperature range	-25°C ... +50°C (max. 95% rH, not condensing)	
DC- Breaker / fuse	no	no
Remote control ON / OFF	yes, with external switch	
Status indication	LED	LED
Alarm contact (insulated Relay contact)	no	yes
Toroidal Transformer (galvanically isolated)	EN61558 (IEC61558)	
Temperature and Load controlled fan	ON 55°C / OFF 45°C, P _D >80%	
RS-232 Interface	no	no
Dimensions (L x W x H)	375 x 260 x 181 mm	456 x 320 x 211 mm
IP Protection	IP20	
Standards	CE	
Weight	15.5 kg	20 kg
Warranty	2 years	



¹⁾ This values correspond to rated voltage 12V DC

SOLON Top Class	15/24	22/24
		
Inverter		
Rated Voltage UDC _{IN}	24V	24V
Input Voltage Range	21.0 ... 32.0V DC	21.0 ... 32.0V DC
Dynamic Low Voltage Cut Off (depending on load)	21.0 ... 18.0V DC	21.0 ... 18.0V DC
Rated current IDC _{IN}	72A	110A
Current IDC _{IN} max.	140A	205A
Rated Power P ₁₀ (10 min at T _A =20°C)	1700VA	2900VA
Rated Power P ₃₀ (30 min at T _A =20°C)	1500VA	2200VA
Continuous Power P _D	1200VA	2000VA
Rated Output Voltage UAC _{OUT}	230V AC, ± 2% (short circuit proof)	
Output Frequency	50Hz, ± 0.5% (true sinewave)	
Rated Output Current IAC _{OUT}	6.7A	9.6A
Short Circuit Current IAC _K (max. 0.5s)	16A	24A
Allowable CosPhi	0.3 ... 1	
Efficiency Factor max.	93%	93%
Adjustable Standby Level (logarithmic)	5 ... 60W	
Consumption Standby/OFF	ca. 0.5W (Test impulse every 800ms) / 0W	
Consumption 230V AC OK	12W	12W
Reset after Short Circuit	every 60s	
Reset after Overload	every 60s	
Reset after Overtemperature	automatically after reaching semiconductor temp. +45°C	
Reset after Battery failure	automatically after reaching UDC _{IN}	
General data		
Ambient Temperature range	-25°C ... +50°C (max. 95% rH, not condensing)	
DC- Breaker / fuse	100A	125A
Remote control ON / OFF	yes, with external switch	
Status indication	LED	LED
Alarm contact (insulated Relay contact)	no	no
Toroidal Transformer (galvanically isolated)	EN61558 (IEC61558)	
Temperature and Load controlled fan	ON 55°C / OFF 45°C, P _D >80%	
RS-232 Interface	no	no
Dimensions (L x W x H)	385 x 260 x 182 mm	456 x 320 x 211 mm
IP Protection	IP20	
Standards	CE	
Weight	16 kg	20 kg
Warranty	2 years	



¹⁾ This values correspond to rated voltage 24V DC

SOLON Top Class	30/24
	
Inverter	
Rated Voltage UDC _{IN}	24V
Input Voltage Range	21.0 ... 32.0V DC
Dynamic Low Voltage Cut Off (depending on load)	21.0 ... 18.0V DC
Rated current IDC _{IN}	150A
Current IDC _{IN} max.	340A
Rated Power P ₁₀ (10 min at T _A =20°C)	3200VA
Rated Power P ₃₀ (30 min at T _A =20°C)	3000VA
Continuous Power P _D	2700VA
Rated Output Voltage UAC _{OUT}	230V AC, ± 2% (short circuit proof)
Output Frequency	50Hz, ± 0.5% (true sinewave)
Rated Output Current IAC _{OUT}	13A
Short Circuit Current IAC _K (max. 0.5s)	35A
Allowable CosPhi	0.3 ... 1
Efficiency Factor max.	94%
Adjustable Standby Level (logarithmic)	5 ... 60W
Consumption Standby/OFF	ca. 0.5W (Test impulse every 800ms) / 0W
Consumption 230V AC OK	22W
Reset after Short Circuit	every 60s
Reset after Overload	every 60s
Reset after Overtemperature	automatically after reaching semiconductor temp. +45°C
Reset after Battery failure	automatically after reaching UDC _{IN}
General data	
Ambient Temperature range	-25°C ... +50°C (max. 95% rH, not condensing)
DC- Breaker / fuse	no
Remote control ON / OFF	yes, with external switch
Status indication	LED
Alarm contact (insulated Relay contact)	yes
Toroidal Transformer (galvanically isolated)	EN61558 (IEC61558)
Temperature and Load controlled fan	ON 55°C / OFF 45°C, P _D >80%
RS-232 Interface	no
Dimensions (L x W x H)	456 x 320 x 211 mm
IP Protection	IP20
Standards	CE
Weight	31 kg
Warranty	2 years

¹⁾ This values correspond to rated voltage 24V DC

SOLON Top Class	22/48	35/48
		
Inverter		
Rated Voltage UDC _{IN}	48V	48V
Input Voltage Range	42.0 ... 64.0V DC	42.0 ... 64.0V DC
Dynamic Low Voltage Cut Off (depending on load)	42.0 ... 36.0V DC	42.0 ... 36.0V DC
Rated current IDC _{IN}	54A	80A
Current IDC _{IN} max.	96A	210A
Rated Power P ₁₀ (10 min at T _A =20°C)	2700VA	3900VA
Rated Power P ₃₀ (30 min at T _A =20°C)	2200VA	3500VA
Continuous Power P _D	2000VA	3200VA
Rated Output Voltage UAC _{OUT}	230V AC, ± 2% (short circuit proof)	
Output Frequency	50Hz, ± 0.5% (true sinewave)	
Rated Output Current IAC _{OUT}	9.6A	15.6A
Short Circuit Current IAC _K (max. 0.5s)	16A	24A
Allowable CosPhi	0.3 ... 1	
Efficiency Factor max.	93%	93%
Adjustable Standby Level (logarithmic)	5 ... 60W	4 ... 40W
Consumption Standby/OFF	ca. 0.5W (Test impulse every 800ms) / 0W	
Consumption 230V AC OK	12W	12W
Reset after Short Circuit	every 60s	
Reset after Overload	every 60s	
Reset after Overtemperature	automatically after reaching semiconductor temp. +45°C	
Reset after Battery failure	automatically after reaching UDC _{IN}	
General data		
Ambient Temperature range	-25°C ... +50°C (max. 95% rH, not condensing)	
DC- Breaker / fuse	80A	100A
Remote control ON / OFF	yes, with external switch	
Status indication	LED	LED
Alarm contact (insulated Relay contact)	no	yes
Toroidal Transformer (galvanically isolated)	EN61558 (IEC61558)	
Temperature and Load controlled fan	ON 55°C / OFF 45°C, P _D >80%	
RS-232 Interface	no	no
Dimensions (L x W x H)	456 x 320 x 211 mm	
IP Protection	IP20	
Standards	CE	
Weight	20 kg	30 kg
Warranty	2 years	

¹⁾ This values correspond to rated voltage 48V DC

SOLON Top Class	25/110	20/36
		
Inverter		
Rated Voltage UDC _{IN}	110V	36V
Input Voltage Range	96.0 ... 148.0V DC	31.0 ... 47.0V DC
Dynamic Low Voltage Cut Off (depending on load)	96.0 ... 84.0V DC	31.0 ... 27.0V DC
Rated current IDC _{IN}	27A	61A
Current IDC _{IN} max.	74A	180A
Rated Power P ₁₀ (10 min at T _A =20°C)	2900VA	2500VA
Rated Power P ₃₀ (30 min at T _A =20°C)	2500VA	2200VA
Continuous Power P _D	2200VA	1800VA
Rated Output Voltage UAC _{OUT}	230V AC, ± 2% (short circuit proof)	
Output Frequency	50Hz, ± 0.5% (true sinewave)	
Rated Output Current IAC _{OUT}	12A	9A
Short Circuit Current IAC _K (max. 0.5s)	16A	24A
Allowable CosPhi	0.3 ... 1	
Efficiency Factor max.	93%	93%
Adjustable Standby Level (logarithmic)	4 ... 40W	
Consumption Standby/OFF	ca. 0.5W (Test impulse every 800ms) / 0W	
Consumption 230V AC OK	13W	12W
Reset after Short Circuit	every 60s	
Reset after Overload	every 60s	
Reset after Overtemperature	automatically after reaching semiconductor temp. +45°C	
Reset after Battery failure	automatically after reaching UDC _{IN}	
General data		
Ambient Temperature range	-25°C ... +50°C (max. 95% rH, not condensing)	
DC- Breaker / fuse	80A	63A
Remote control ON / OFF	yes, with external switch	
Status indication	LED	LED
Alarm contact (insulated Relay contact)	yes	no
Toroidal Transformer (galvanically isolated)	EN61558 (IEC61558)	
Temperature and Load controlled fan	ON 55°C / OFF 45°C, P _D >80%	
RS-232 Interface	no	no
Dimensions (L x W x H)	456 x 320 x 211 mm	456 x 320 x 211 mm
IP Protection	IP20	
Standards	CE	
Weight	25 kg	19.5 kg
Warranty	2 years	

¹⁾ This values correspond to rated voltage 36V DC resp. 110V DC

11. Additional sheet for cable connections

View of clamp on C-rail

Direct voltage (DC)

+ = battery plus (+)

- = battery minus (-)

Remote

1 = remote off-control

2 = remote off-control

Alternating voltage (AC)

P = phase

N = neutral

E = earth

SOLON Top Class 20/12

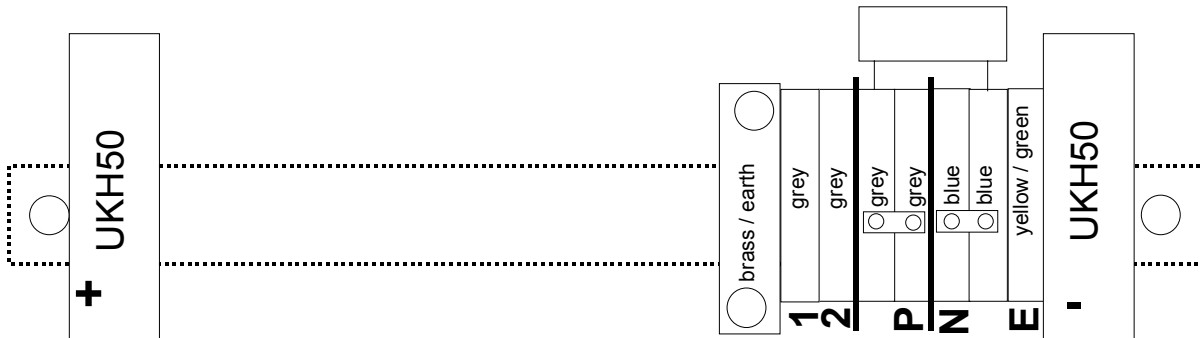

SOLON Top Class 13/12

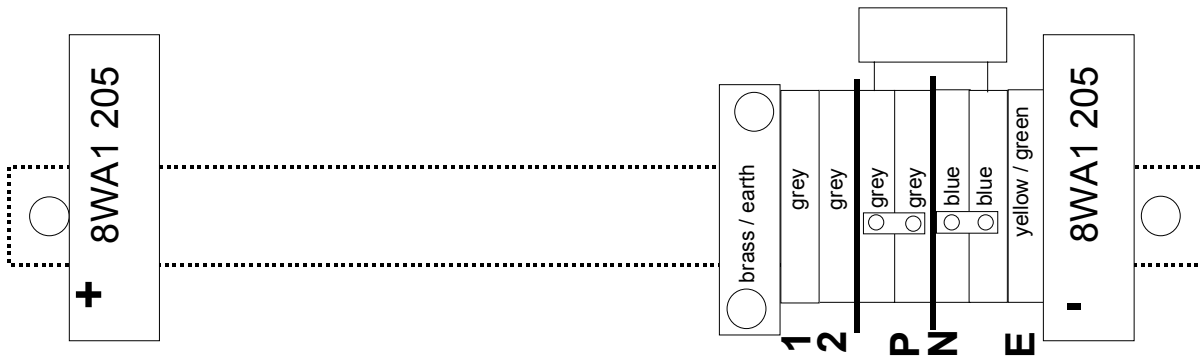

SOLON Top Class 15/24

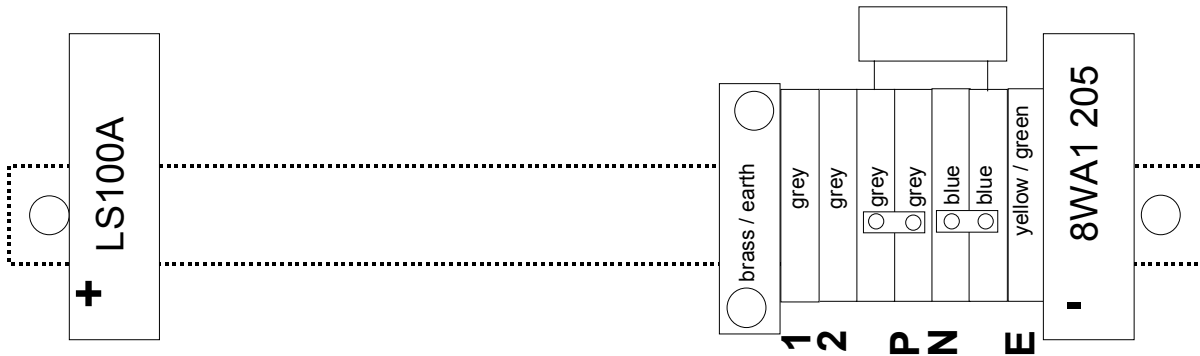

SOLON Top Class 22/24

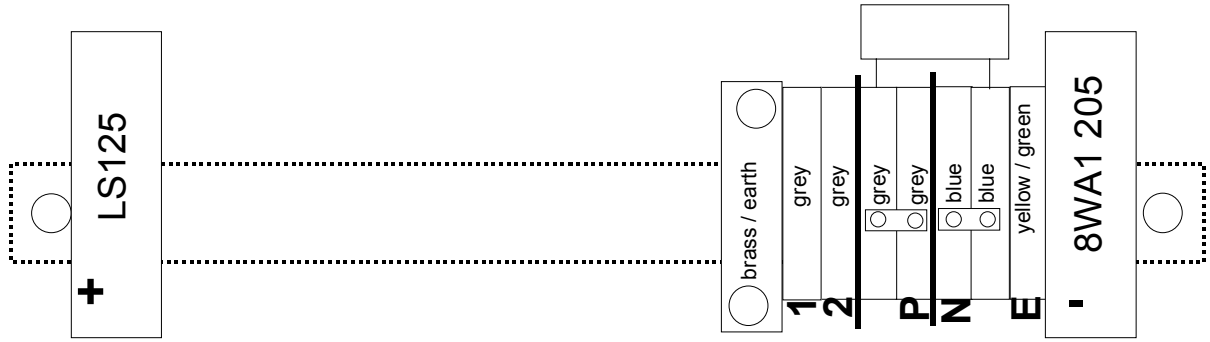

SOLON Top Class 30/24

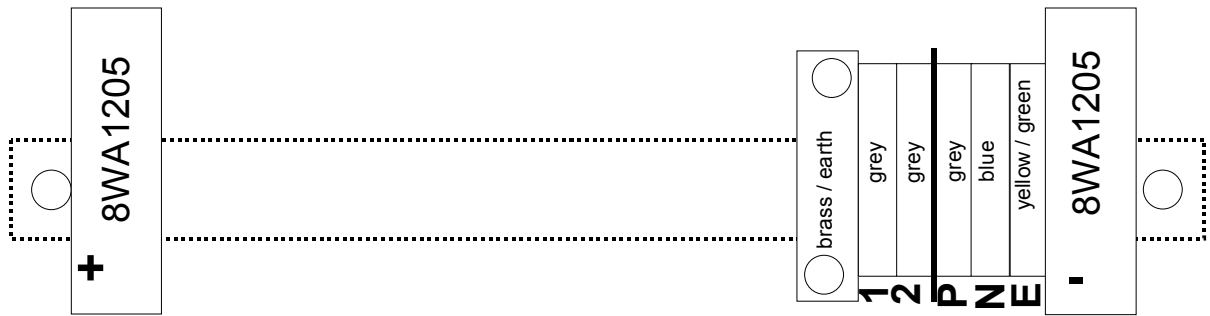

SOLON Top Class 22/48

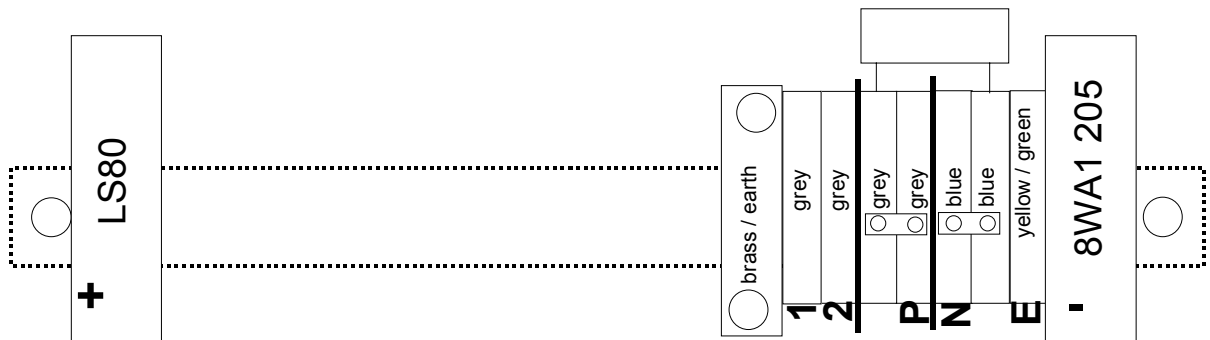

SOLON Top Class 35/48

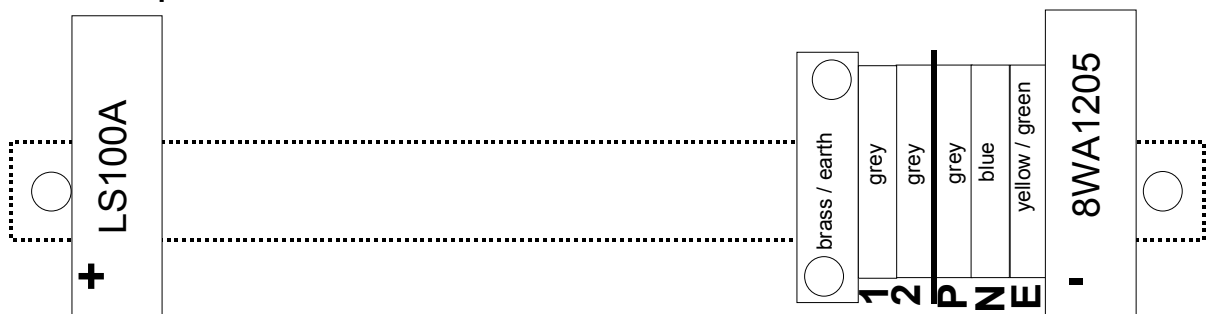

SOLON Top Class 25/110

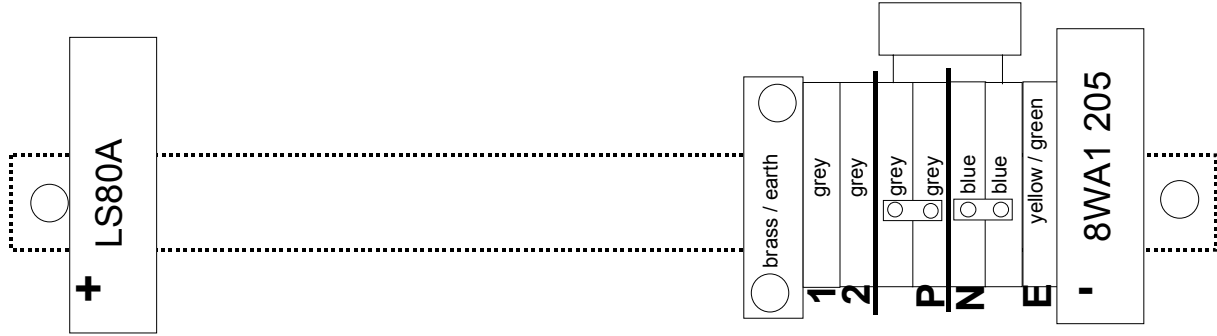

SOLON Top Class 20/36

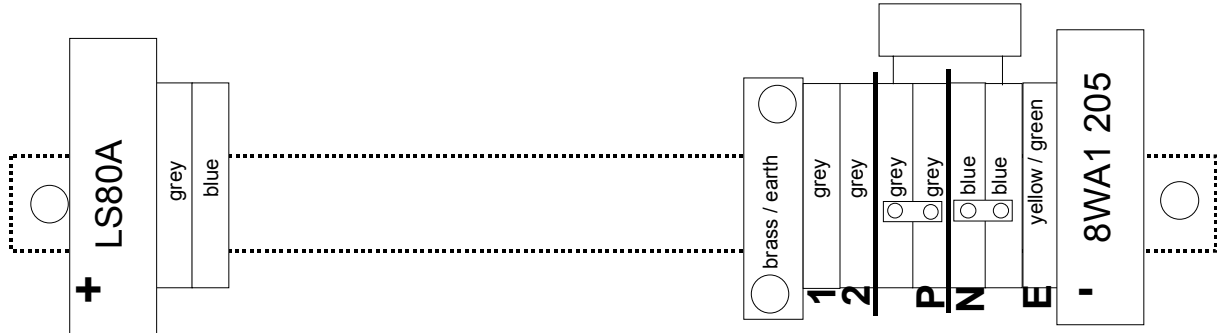

9. Warranty (short form)

Dear Customer,

Thank you for buying this SOLON Inverters AG product. In the event that your SOLON Inverters AG product needs guarantee service you should return it to the retailer from whom it was purchased.

We guarantee SOLON Top Class appliances in accordance with statutory/country-specific regulations (proof of purchase by invoice or delivery note). Damage attributable to normal wear and tear, overload or improper handling will be excluded from the guarantee. In case of complaint please send the unit with the original packaging, undismantled to your dealer or an SOLON Inverters AG service centre for inverters. Please be aware of the information we need to repair the unit as soon as possible (page 4, Maintenance and Spare parts).

SOLON Inverters AG is not responsible for costs arising for transport of the unit or damage that occur if the unit is out of service. If you wish we will send you our complete documentation about our guarantee terms.